



OVERHEMD II.

Made to Measure

OVERHEMD II.	PASVORM	4
	KRAAG	5
	KRAAGBALIJNEN	9
	OORKANT	10
	ONDERKANT	12
	ZAKKEN	13
	RUG	14
	MOUWEN	16
	MONOGRAM	18
	STICKELS	19
	MODEL OPTIES	19
	MATERIAAL OPTIES	21



Onze hemden zijn gemaakt volgens de hoogste kwaliteits eisen en wij maken gebruik van de laatste nieuwheden en naai technieken. Inbegrepen zijn vele bemerkningen die U zult vinden in Confort en Pasvorm.

Fijnste materialen gebruikt in Kragen en Manchetten

Bij de Rugpas en de Mouw split is alles aangepast aan het stof patroon

Fijn stiksel op de kanten met 8 steken per cm

Grote keuze in kwaliteits knopen aangenaaid met een kruissteek

Initialen

Hoge kwaliteit van knoopsgaten

Gedeeld rugpas op stofpatroon aangepast

Zijnaad met Verdekte split sluiting

Langere ruglengte

Konfortabele basis pasvorm met veel Veranderingsmogelijkheden

Mouwsplit met knoopsluiting en op Stofpatroon aangepast

Enkel naalds zijnaden

Fijn stiksel op de zoom.

Kode

BLU

BLUE line



Kraag
met 1 knoop
Kraaghoogte 30, 35 en 40 mm

Kraag
met 2 knopen
Kraaghoogte 40, 45 en 50 mm

Kraag
met 3 knopen
Kraaghoogte uitsluitend 50 mm

Hai

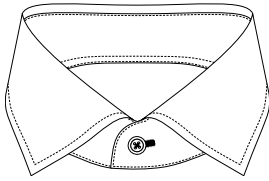

Kode
1Q1

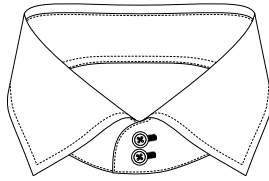

Kode
1Q2

Windsor

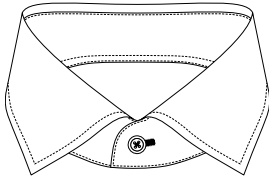

Kode
1A1

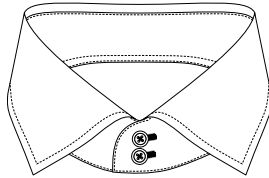

Kode
1A2

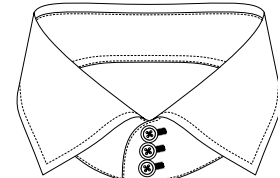

Kode
1A3

Kent

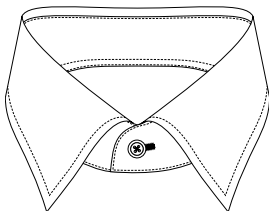

Kode
1B1

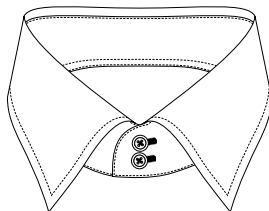

Kode
1B2

London

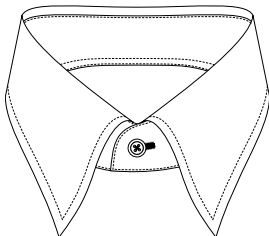

Kode
1C1

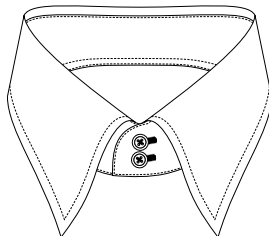

Kode
1C2

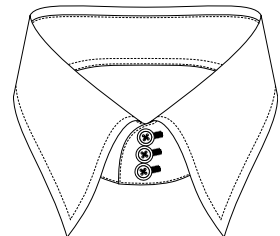

Kode
1C3

King

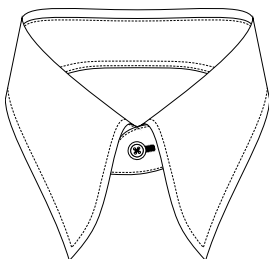

Kode
1D1

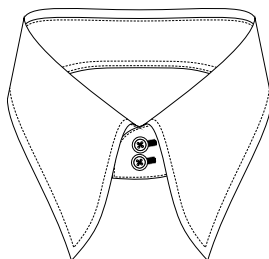

Kode
1D2

	Model / Stand	30 mm	35 mm	40 mm	45 mm	50 mm
!!! translation!!!	Hai	80	85	90	99	107
	Windsor	73	78	83	92	100
	Kent	73	78	83	92	100
	London	75	80	86	92	97
	King	78	83	89	95	100

Picadilly kraag

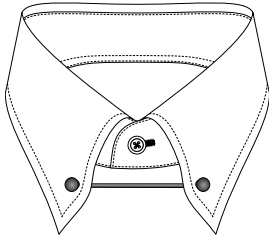

Kode
111
Punt kraag

Kraaghoogte
30,35,40 en 45 mm

Geleverd zonder
pin

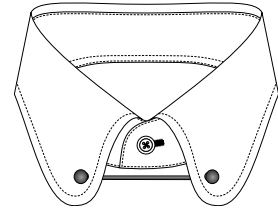

Kode
1J1
Ronde kraag

Tab kraag

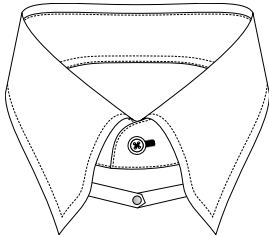

Kode
1K1
Punt kraag

Kraaghoogte
30,35,40 en 45 mm

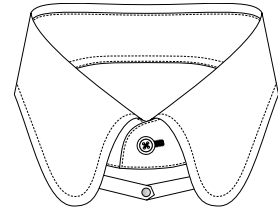

Kode
1L1
Ronde kraag

Vleugel kraag

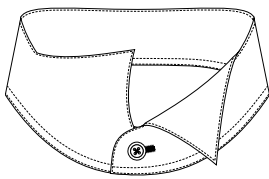

Kode
1H1
!!! translation!!!

Kraaghoogte
30, 40 mm

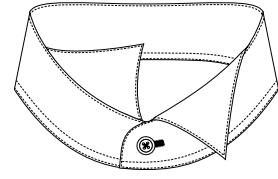

Kode
1P1
!!! translation!!!

	Model / Stand	30 mm	35 mm	40 mm	45 mm
!!! translation!!!	Picadilly kraag / Tab kraag	65	70	76	82
	Vleugel kraag	---	55	60	---

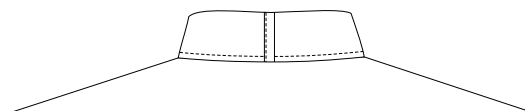

Optie
BTL
Vlinderstrik lus



Button Down

langer

Kraag met 1 knoop
Kraaghoogte 30, 35 en 40 mm

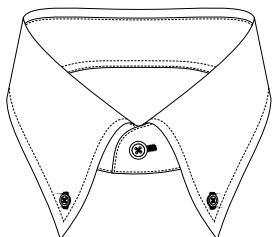

Kode
1E1

Kraag met 2 knopen
Kraaghoogte 40, 45 en 50 mm

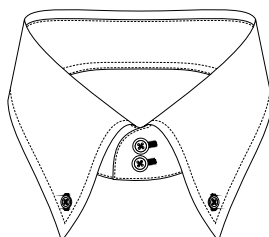

Kode
1E2

Kraag met 3 knopen
Kraaghoogte uitsluitend 50 mm

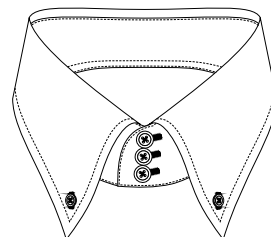

Kode
1E3

korter

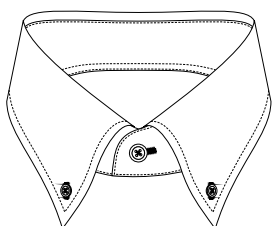

Kode
1EJ1

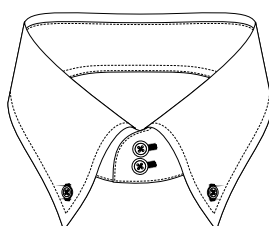

Kode
1EJ2

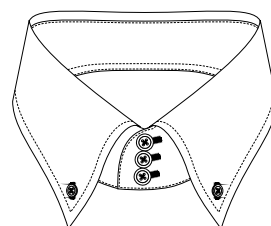

Kode
1EJ3

langer

Button Down,
verdekte sluiting

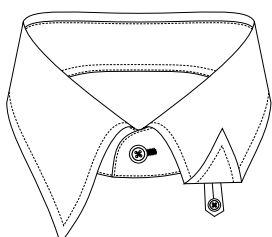

Kode
1F1

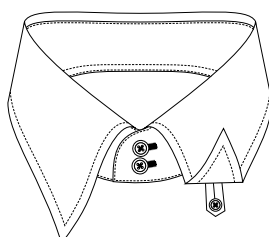

Kode
1F2

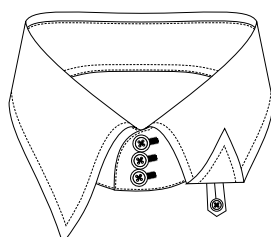

Kode
1F3

korter

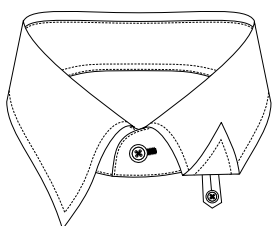

Kode
1FJ1

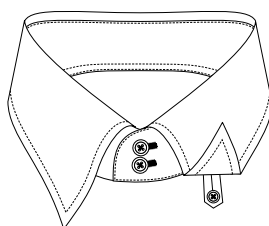

Kode
1FJ2

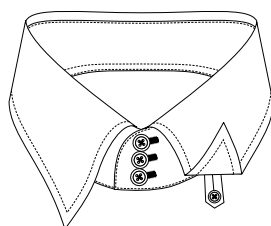

Kode
1FJ3

	Model / Stand	30 mm	35 mm	40 mm	45 mm	50 mm
!!! translation!!!	Button Down langer	78	83	88	93	98
	Button Down korter	65	70	75	80	85

Fashion kraag

Collar Hai curved, 1 button

Kode

1QC1

Kraaghoogte
30, 40 mm

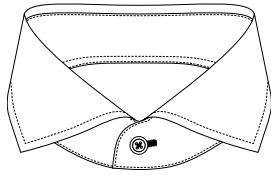

Collar Hai curved, 2 buttons

Kode

1QC2

Kraaghoogte
40 mm

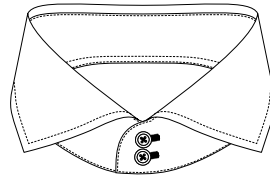

Kraag Tiny, 1 knoop

Kode

1T1

Kraaghoogte 30, 35 en 40 mm

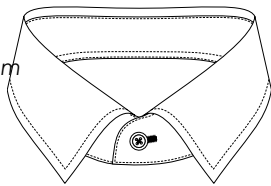

Kraag Smart, 1 knoop

Kode

1S1

Kraaghoogte 30, 35 en 40 mm

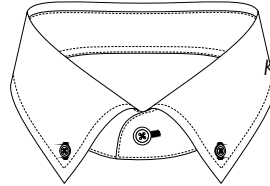

	Model / Stand	30 mm	35 mm	40 mm
!!! translation!!!	Hai	---	85	90
	Tiny / Smart	55	60	65

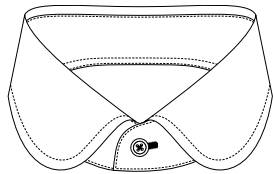

Kraag Penny, rond (London)

Kode

1M1

Kraaghoogte 30, 35 en 40 mm

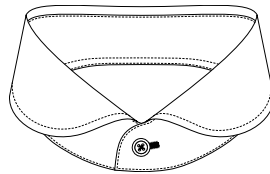

Kraag Eton, 1 knoop

Kode

1U1

Kraaghoogte 30, 35 en 40 mm

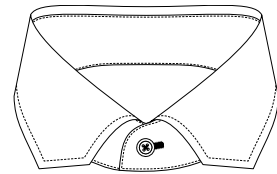

Chisel kraag, 1 knoop

Kode

1CH1

Kraaghoogte
30, 40 mm



Nehru kraag

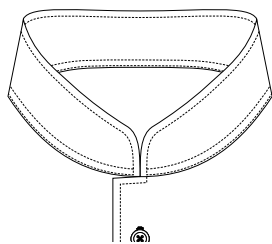

Kode
1G0

Kraaghoogte
35 mm

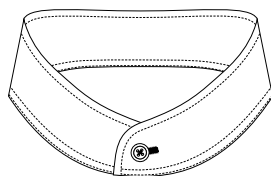

Kode
1G1

Kraaghoogte
35 mm

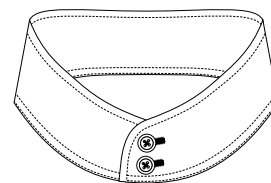

Kode
1G2

Kraaghoogte
40 mm

Speciale kraag

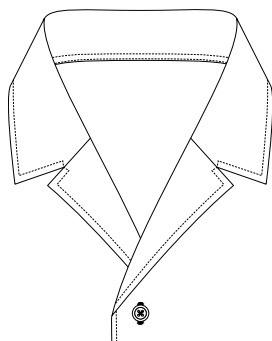

Kode
1N1
Casual kraag
Kraaghoogte
35 mm

*Uitsluitend mogelijk
met voorkant 2B!*

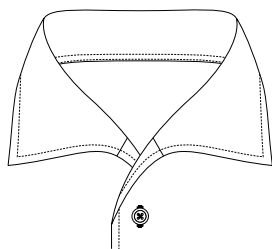

Kode
1O1
Vario kraag
Kraaghoogte
35 mm

*Uitsluitend mogelijk
met voorkant 2B!*

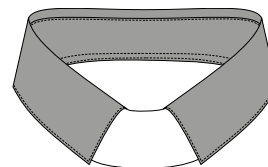

Vicar kraag
Kode
1G11
Kraaghoogte
30 mm
Inclusief Slip in kraag

KRAAGBALIJNEN

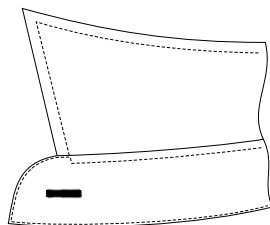

Kode
KSL01
Zonder balijnen

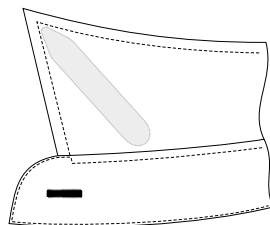

Kode
KSL02
Met balijnen

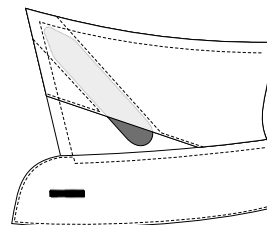

Kode
KSL03
Losse balijnen

Variant
001
Diagonal

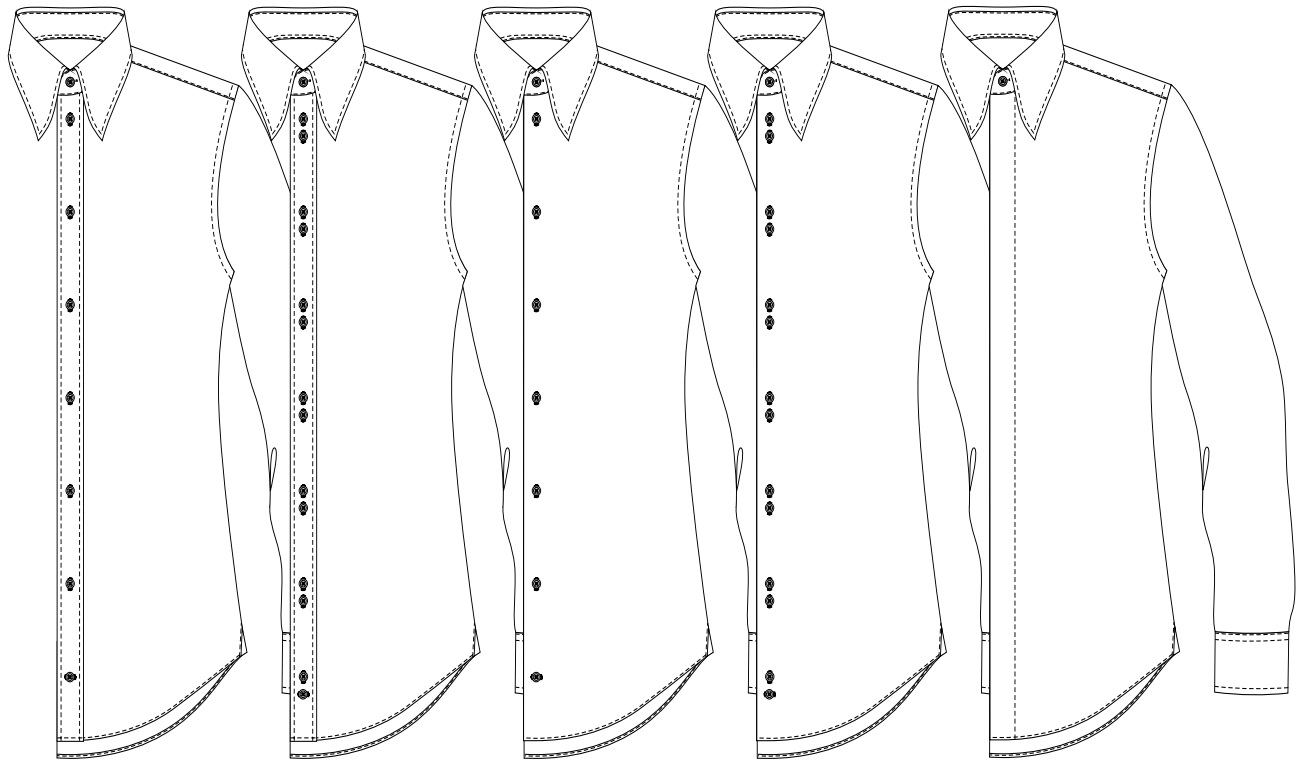

Kode

2A1

Voorkant met lijst
Voorpas breedte 35 mm

Kode

2A2 *

Voorpand met
knooplijst, Gepaarde
knoopstand

Kode

2B1

Voorkant zonder lijst

Kode

2B2 *

Voorkant zonder
lijst, gepaarde
knoopstand

Kode

2C1

Voorkant met
verdekte lijst

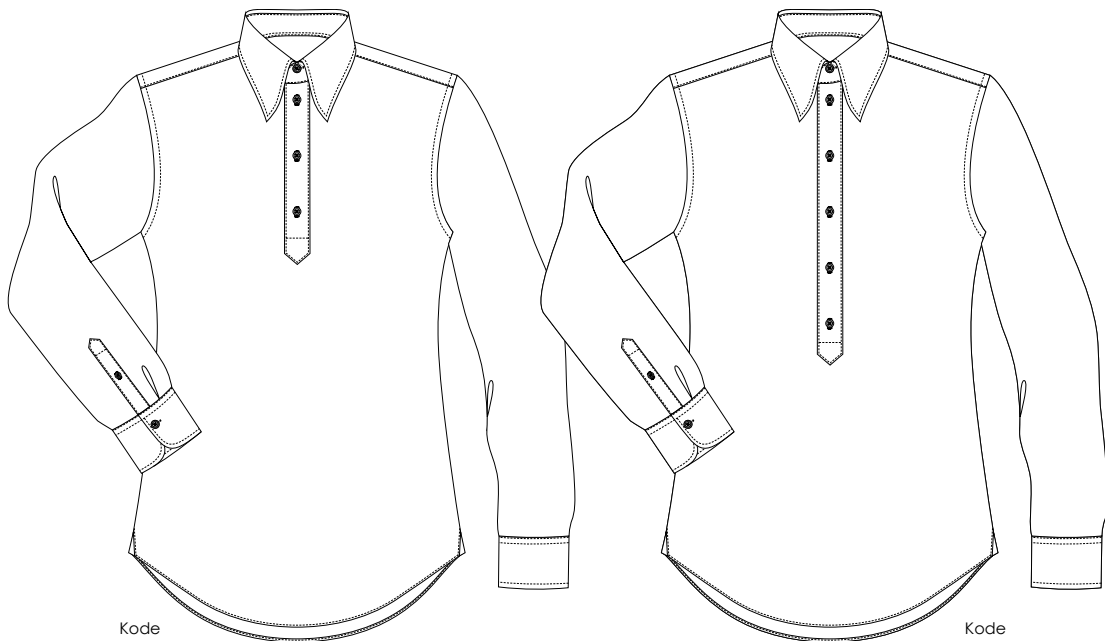

Kode

2F3

Polo shirt sluiting, 3 knoops
Voorpas breedte 30 mm
Voorpas lengte 20 cm

Kode

2F5

Polo shirt sluiting, 5 knoops
Voorpas breedte 30 mm
Voorpas lengte 32 cm

Alle varianten zijn ook beschikbaar met DAMES
SLUITING, Knopen op de linkerkant zoals gedragen.

Optie Damessluiting - knoopsgaten rechts



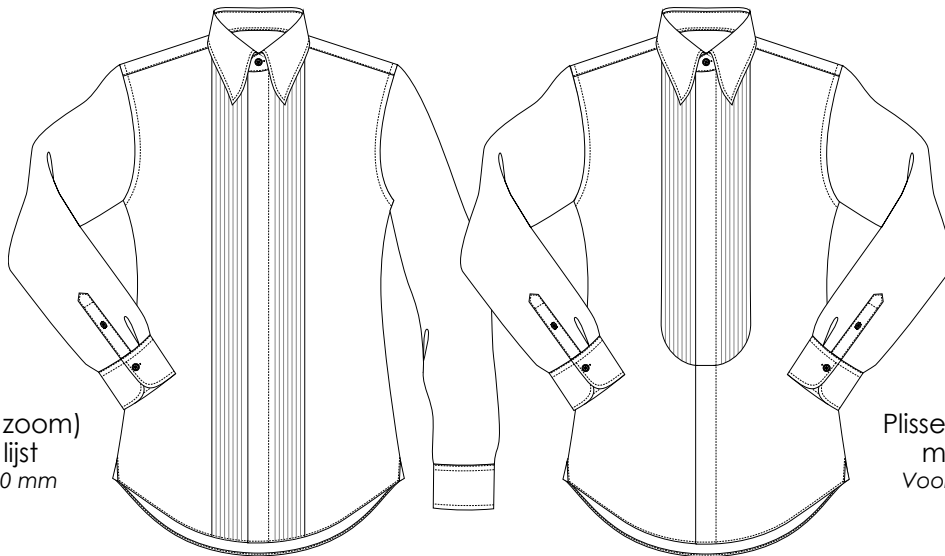

Kode

2D1*

Plissee hemd (tot zoom)
met verdekte lijst
Voorpas breedte 30 mm

Kode

2E1*

Plissee hemd (tot taille)
met verdekte lijst
Voorpas breedte 30 mm

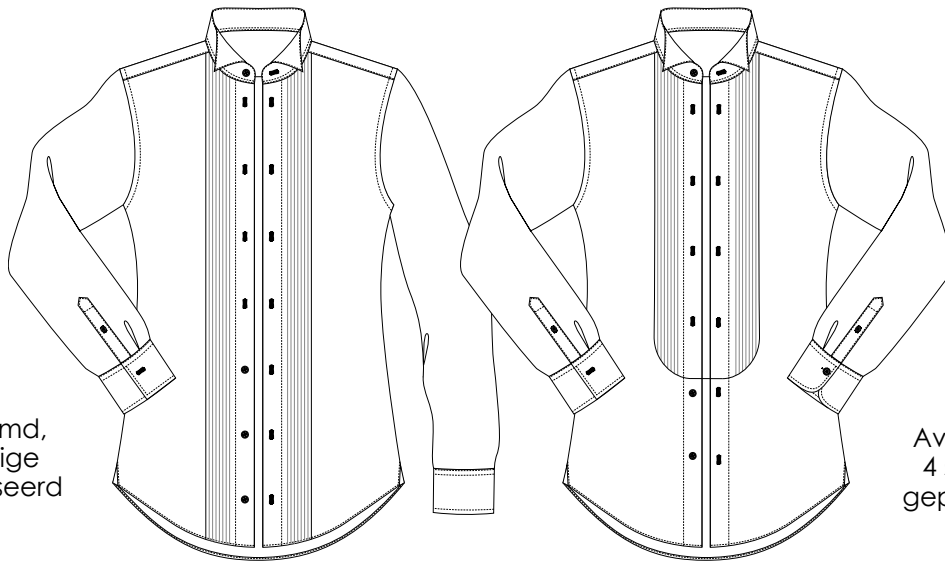

Kode

2G1*

Avond overhemd,
4 studs, volledige
voorkant geplisseerd

Kode

2H1*

Avond overhemd,
4 studs, voorkant
geplisseerd tot taille

Het actuele aanbod voor Plissé vind U in onze stof
collectie.



Kode

2I1*

Avond overhemd, 4
studs, zonder plissee

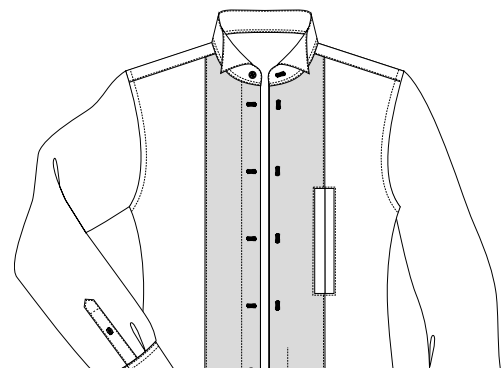

Optie

HA

Handknoopsgat op
linker kant

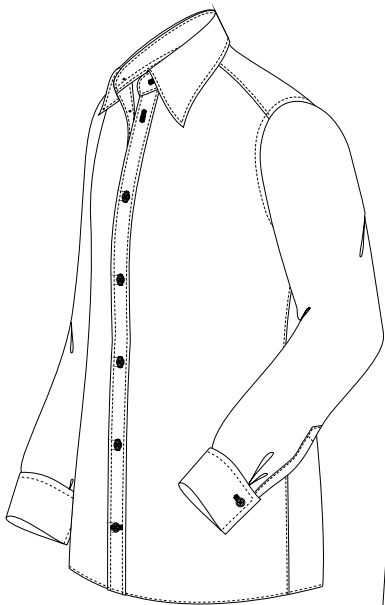

Kode
3A Onderkant
overhemd recht

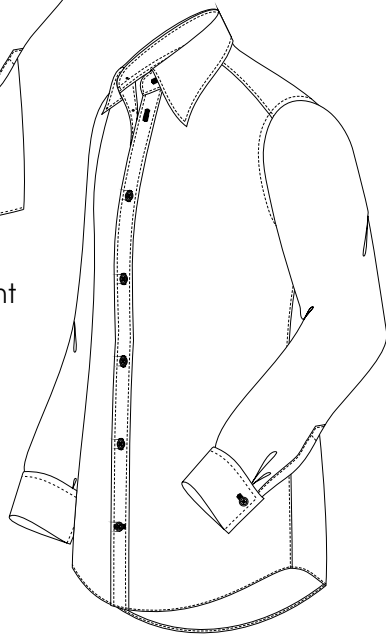

Kode
3B Onderkant
overhemd rond

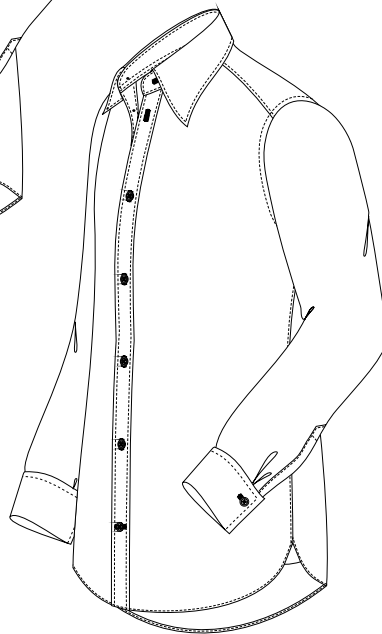

Kode
3C Onderkant overhemd
rond met vlinder
(altijd wit)

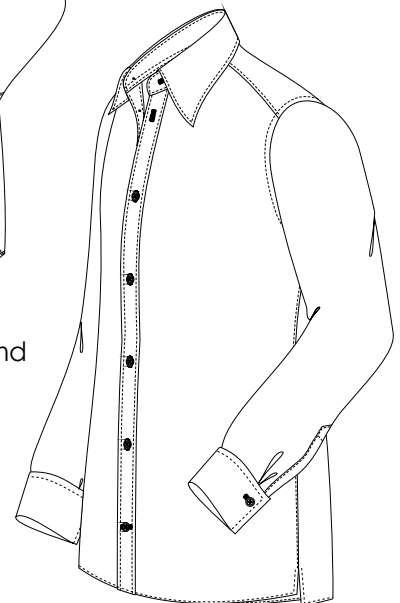

Kode
3D Onderkant overhemd
recht met split
(Rugpand 2 cm langer)



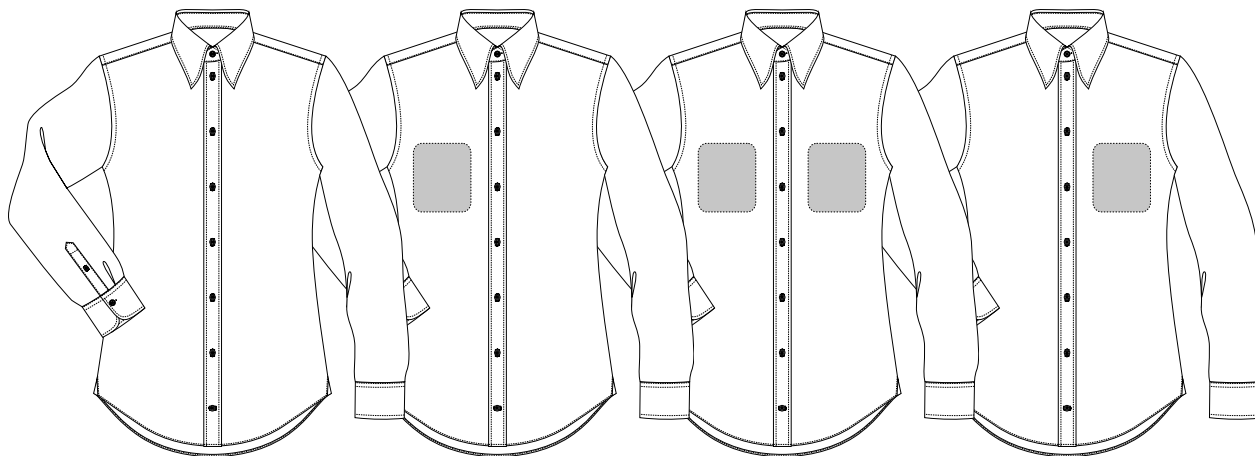

Kode
4A
Zonder borstzak

Kode
4XR
Borstzak Rechts

Kode
4XB
Twee borstzakken

Kode
4XL
Borstzak Links

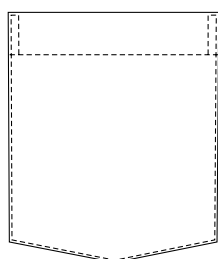

Kode
4BL
Borstzak in puntvorm, links

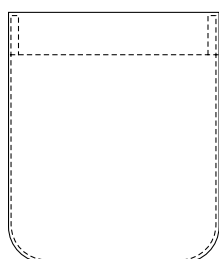

Kode
4CL
Borstzak rond, links

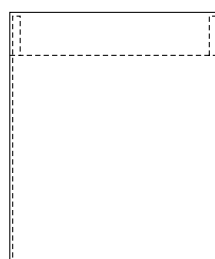

Kode
4EL
Borstzak recht, links

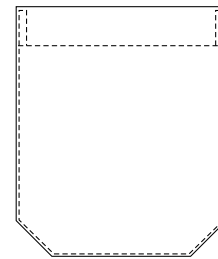

Kode
4DL
Borstzak schuin, links

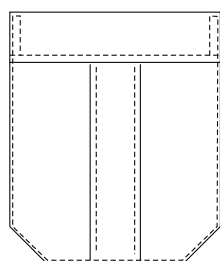

Kode
4FL
Borstzak schuin, met lijst, links

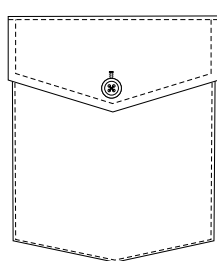

Kode
4GL
Puntvormige borstzak, met klep, knoopsluiting, links

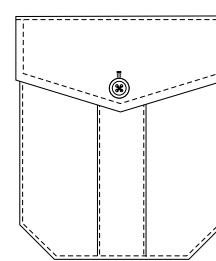

Kode
4ML
Zak met schuine hoeken, stolpplooi met klep en knoop sluiting, links

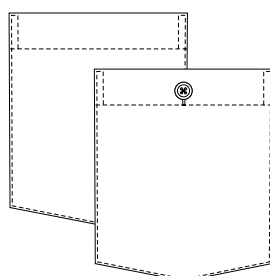

Variant
OV
Zonder sluiting

Variant
MV
Sluiting met knoop

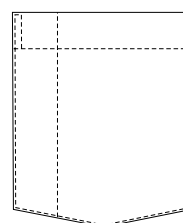

Optie
KS
Pen pocket - stitching
4 cm

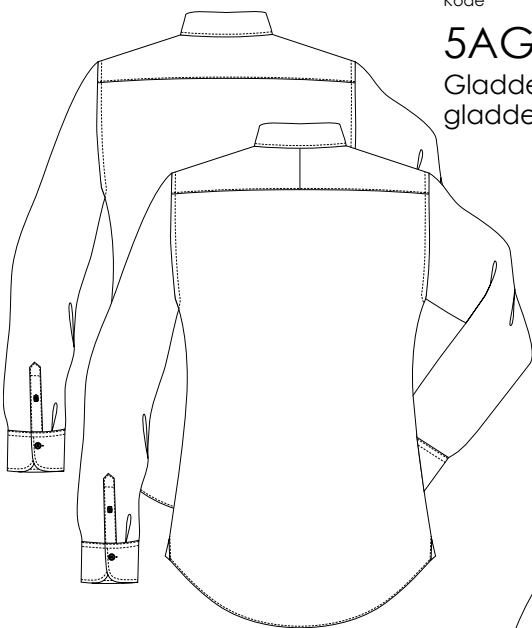

Kode

5AG

Gladde rug, zonder plooiën,
gladde yoke

Kode

5AT

Gladde rug, zonder plooiën,
gedeelde yoke

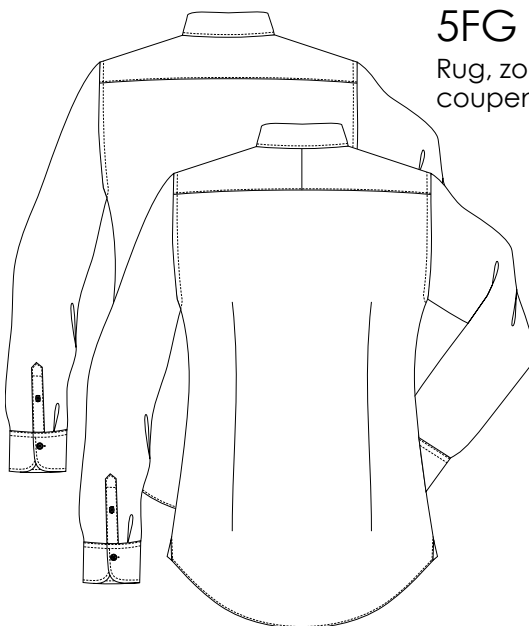

Kode

5FG

Rug, zonder plooiën met
coupnaden, gladde yoke

Kode

5FT

Rug, zonder plooiën met
coupnaden, gedeelde yoke

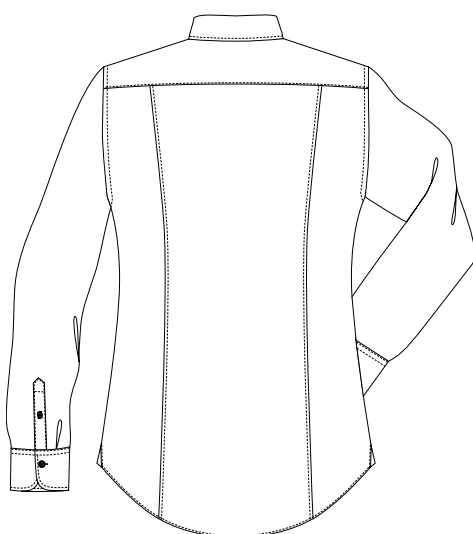

Kode

5HG

Rug naden



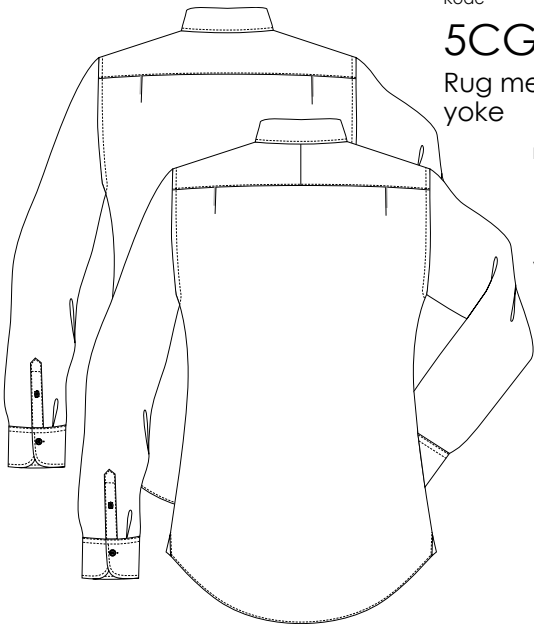

Kode

5CG

Rug met 2 zijplooien, gladde yoke

Kode

5CT

Rug met 2 zijplooien, gedeelde yoke

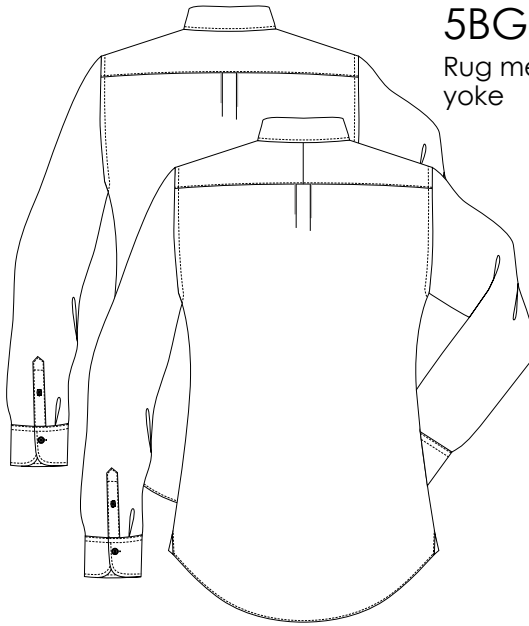

Kode

5BG

Rug met centrale plooi, gladde yoke

Kode

5BT

Rug met centrale plooi, gedeelde yoke

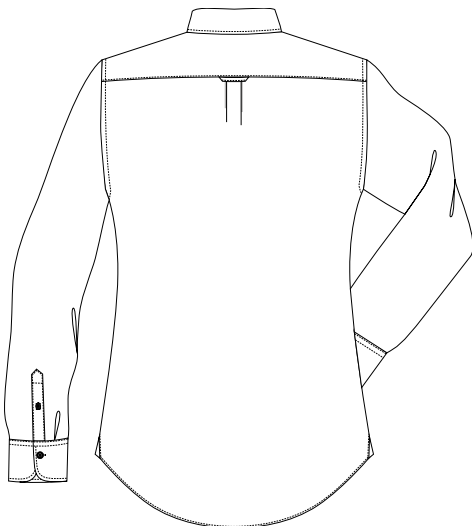

Kode

5DG

Rug, centrale plooi, gladde yoke met ophanglusje

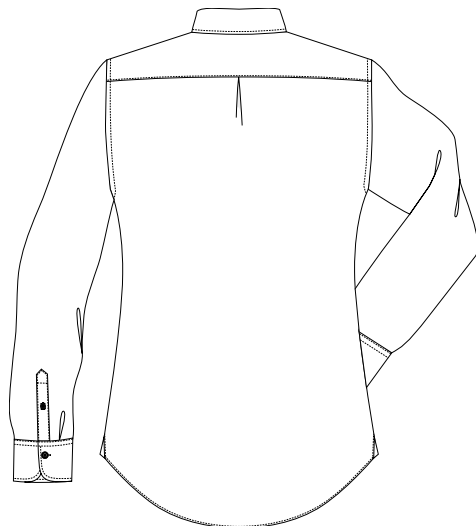

Kode

5EG

Rug, stolpplooi, gladde yoke

1 knoop
Manchet hoogte 50 of 65 mm

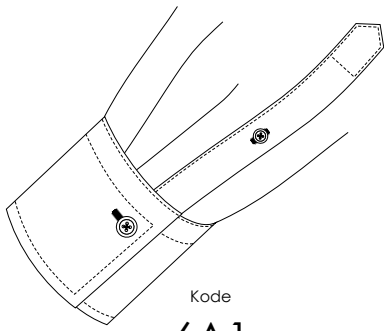

Kode
6A1

2 knoops
Manchet hoogte 65 of 80 mm

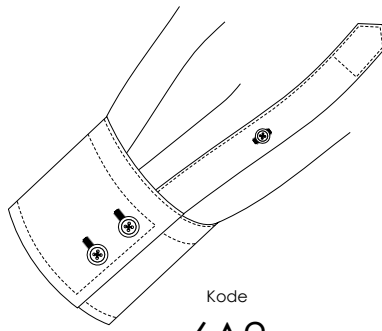

Kode
6A2

3 knopen
Manchet hoogte 80 mm

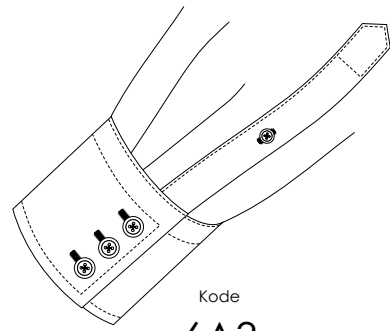

Kode
6A3

Enkel manchet
recht

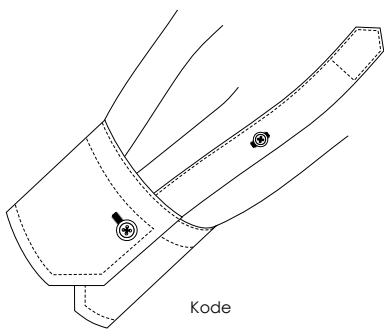

Kode
6B1

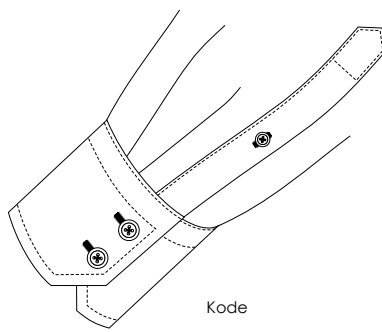

Kode
6B2

Enkel manchet
schuin

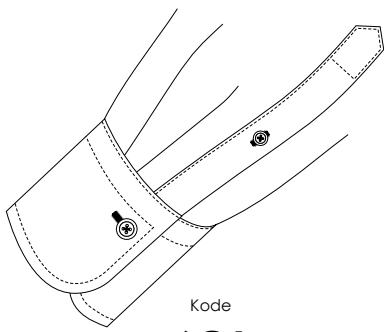

Kode
6C1

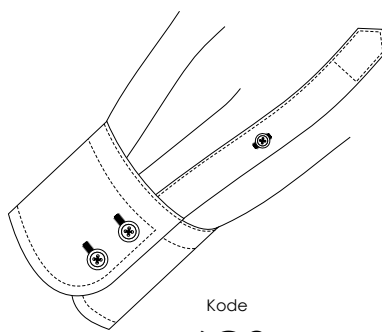

Kode
6C2

Enkel manchet
rond

Wiernermanchet - tweede
knoopsgat

Optie
WM

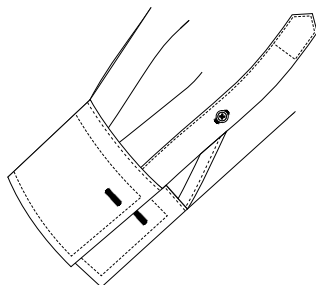

Optie
SO
Mouwsplit zonder sluitknopen

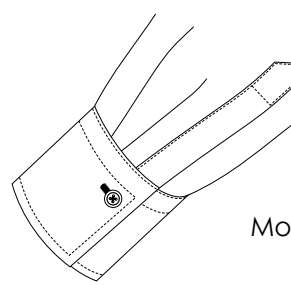

Dubbele manchetten

Manchet hoogte 70, 80 of 90 mm

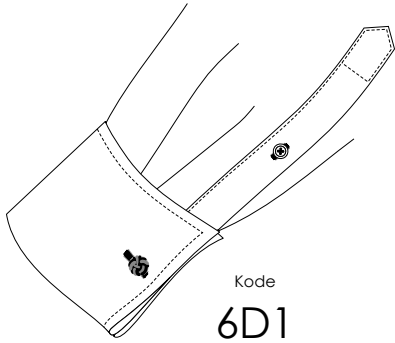

Kode
6D1
Recht

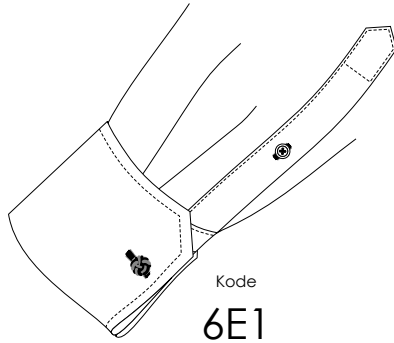

Kode
6E1
Schuin

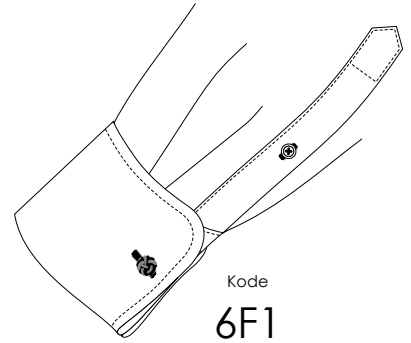

Kode
6F1
Rond

Optie

SM

Dubbele manchet -
derde knoopsgat

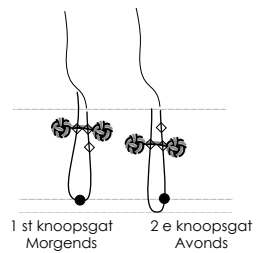
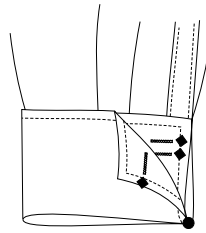

Dubbele manchetten met knopen

Manchet hoogte 70 of 90 mm

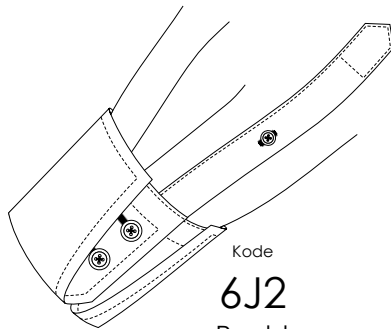

Kode
6J2
Recht

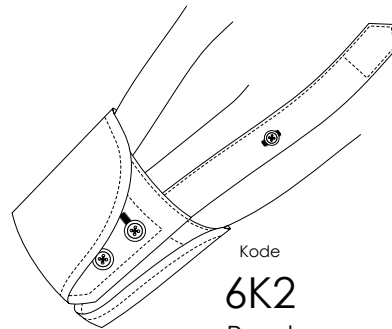

Kode
6K2
Rond

Korte mouwen

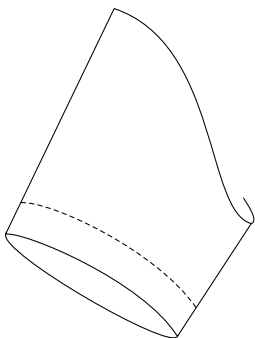

Kode
6G1
Korte mouw,
doorgestikt

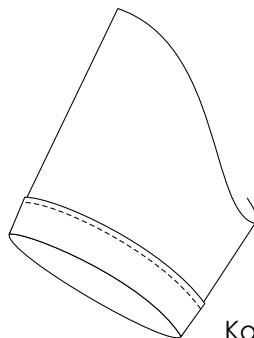

Kode
6H1
Korte mouw, zoom
met omslag en
overstiksel

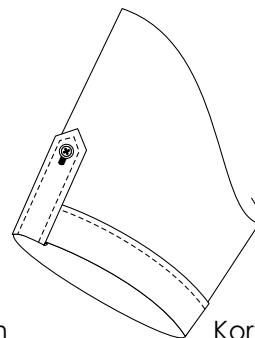

Kode
6I1
Korte mouw, omslag
doorgestikt met lus

Kode
7A
Zonder monogram

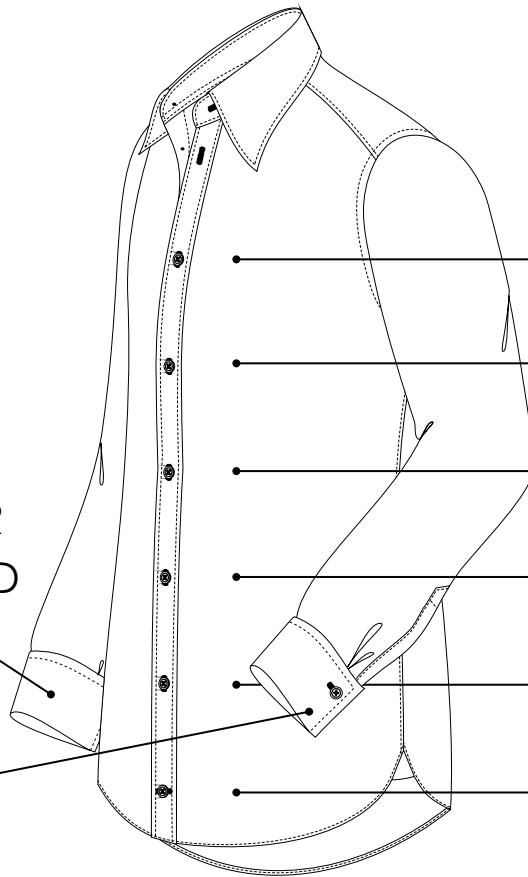

Monogram
op de voorkant

Kode **7V2**
2e knoop

Kode **7V3**
3e knoop

Kode **7V4**
4e knoop

Kode **7V5**
5e knoop

Kode **7V6**
6e knoop

Kode **7VL**
Laatste knoop

Kode
Rechter manchet
Rechter manchet,
diagonaal
Kode **7MR**
7MRD

Kode
Linker manchet
Linker manchet,
diagonaal
Kode **7ML**
7MLD

Positie op de
manchet

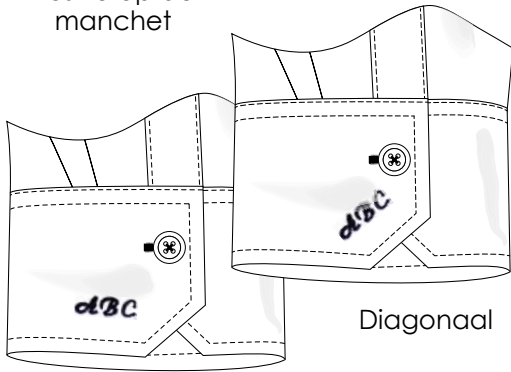

Horizontaal

Diagonaal

Kode **7T1**
Borstzak lijst

Kode **7T2**
Midden van de
borstzak

A B C D E
A B C D E
A B C D E

PA, Handschrift Italic

TA, Drukschrift Italic

TN, Drukschrift Regular

Vermeld de kleur van de initialen
op Uw order



STICKELS

Kode **8A**
Zonder stiksel

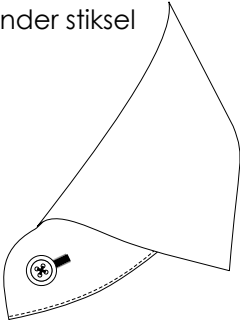

Kode **8B1**
Stiksel 1 mm

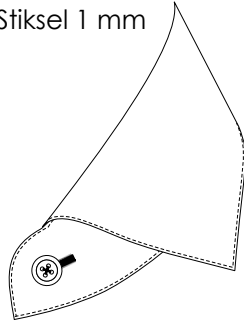

Kode **8B5**
Stiksel 5 mm

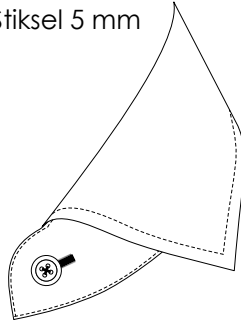

Kode **8B7**
Stiksel 7 mm

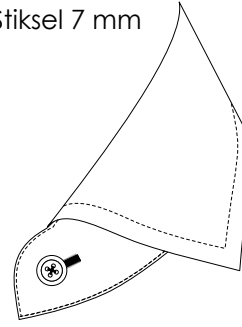

Kode **8C5 ***
HSE 5 mm
(kraag,
manchet en
voorlijst)



Model opties

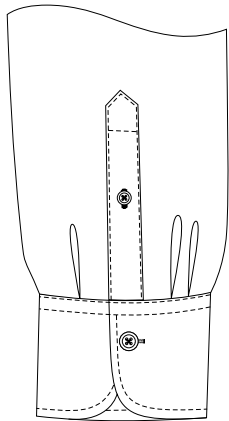

Standaard
Normale mouw , !!!
translation!!!

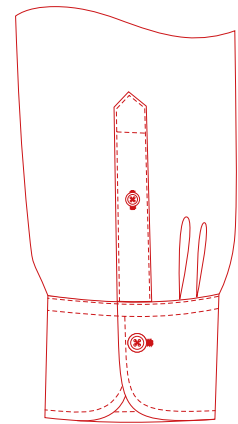

Optie **SA**
Slim sleeve, 2 folds

Als optie kunt U losse onderdelen bestellen:

Optie

Extra kraag

Optie

Extra manchetten

Optie

Extra kraag en
manchetten

Voorpand

Optie **FD**
Voorpand coupenaden



Optie **FS**
Voorpand naden



Optie *
Epaulet

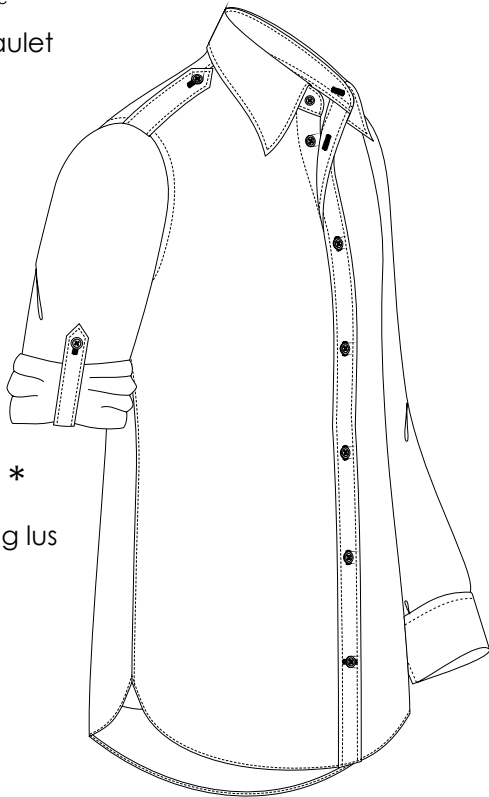

Optie **STA** *
Mouw omslag lus

Optie **GSC**
Mouw kop met
ruimte ingewerkt



Optie **GSF**
Manchet met
ruimte ingewerkt

Optie **GBS**
Rug en mouw
kop met ruimte
ingewerkt





Kontrast - Kraag en Staanders *

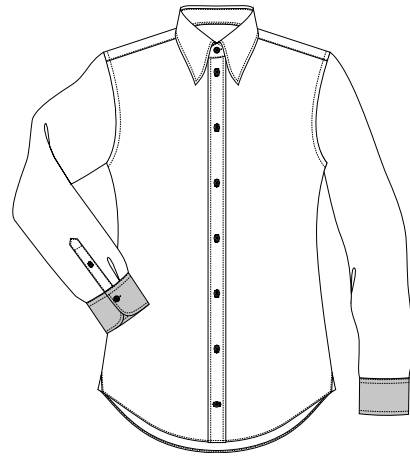

Kontrast - Manchetten *

Kontrast - Kraag binnenstaander *

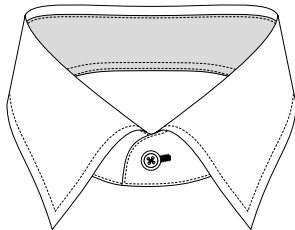

Kontrast - Kraag buitenstaander *

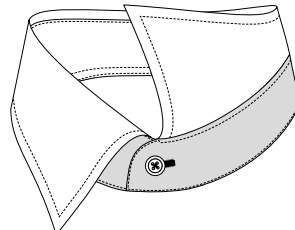

Kontrast - Buitenkraag *

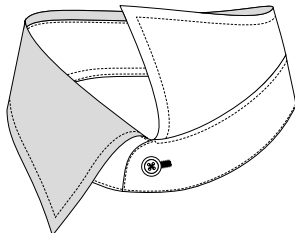

Kontrast - Onderkraag *

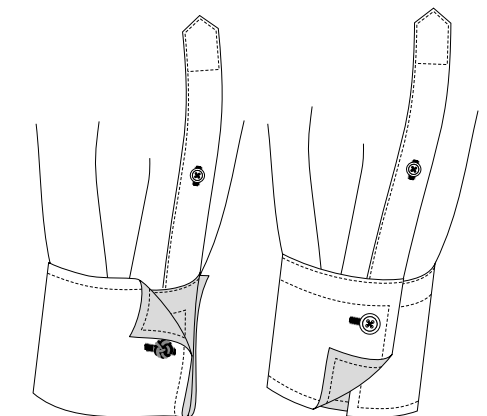
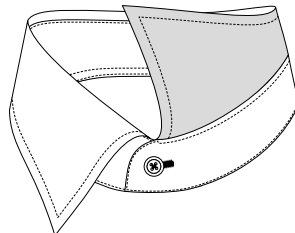

Dubbel manchet

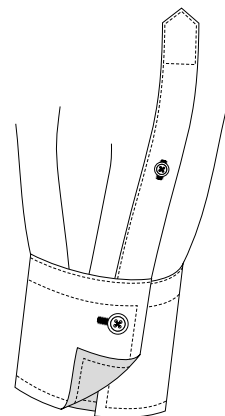

Enkel manchet

Kontrast - Binnenkant Manchetten *

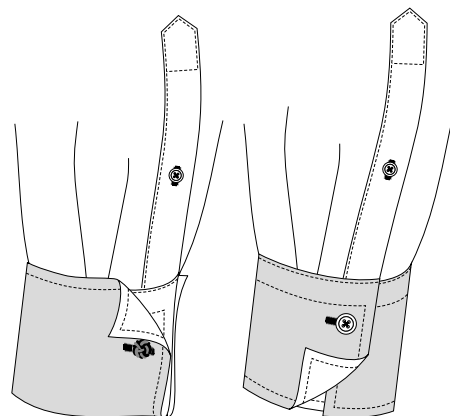

Dubbel manchet

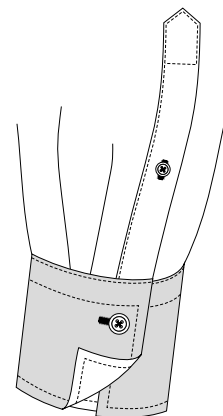

Enkel manchet

Kontrast - Buitenkant Manchetten *

Kontrast - Stiksels *

Bij deze optiekeuze passen Wij de stiksels aan op alle aangeduide naden:

Jukstuk
Kraag en kraagstaander

Armsgat

Voorkant lijst

Manchetten

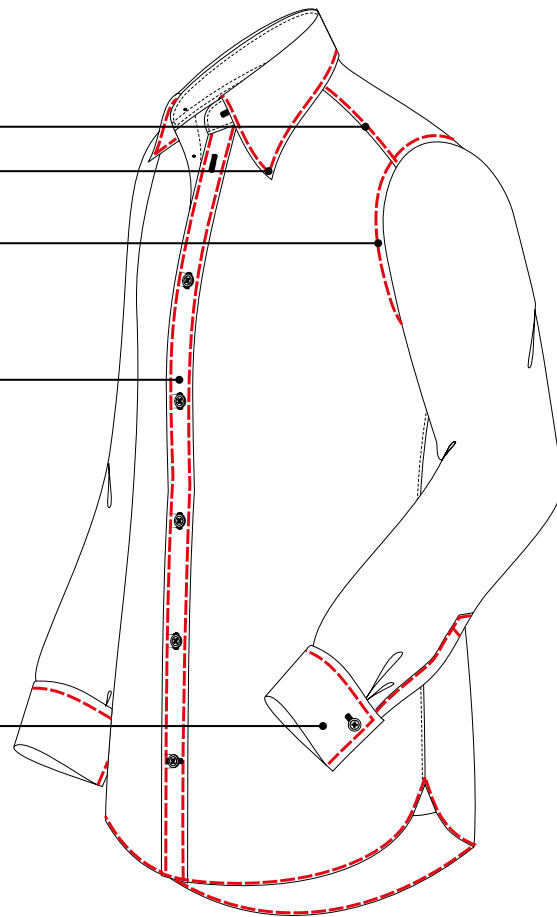

Verschillende contrasten

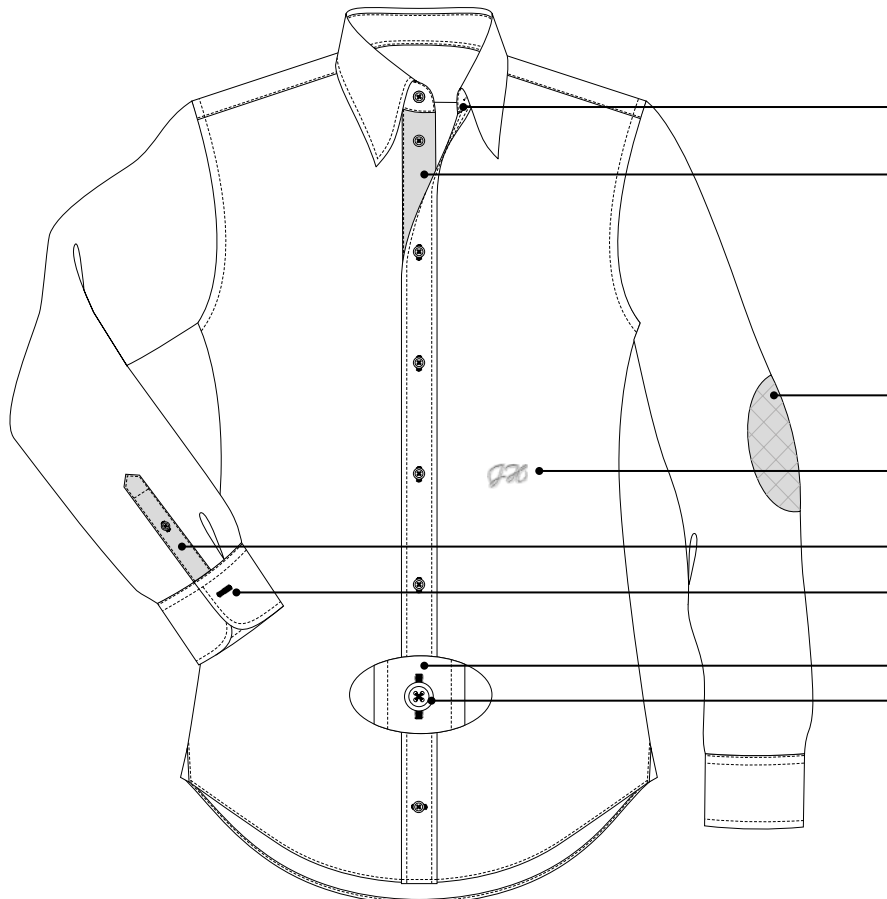

Kontrast - Kraagknoopsgaten *

Kontrast - Knooplijst *

Kontrast - Elleboogstukken *
Altijd diagonaal opgenaaid

Kontrast - Monogram Kleur

Kontrast - Mouwsplit *

Kontrast - Manchetknoopsgaten

Kontrast - Knoopsgaten *

Kontrast - Knoop aanzetten *



KRAAGSTEVIGHEID

U heeft een keuze uit 4 verschillende stevigheden voor kragen en manchetten:

COLLAR EXTRA SOFT

COLLAR SOFT

COLLAR NORMAL

COLLAR HARD

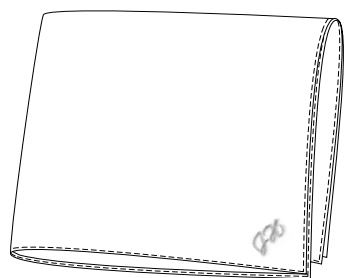

Pocket square *

Pocket square with monogram *



Paarlmoer Baleinen *



Geschenkverpakking *



MADE TO MEASURE